



Audio Jack & Panel Assemblies

Bantam & Longframe

Features and Benefits



... see page 54

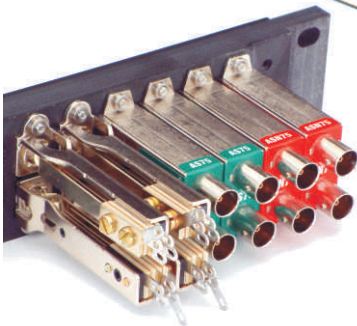
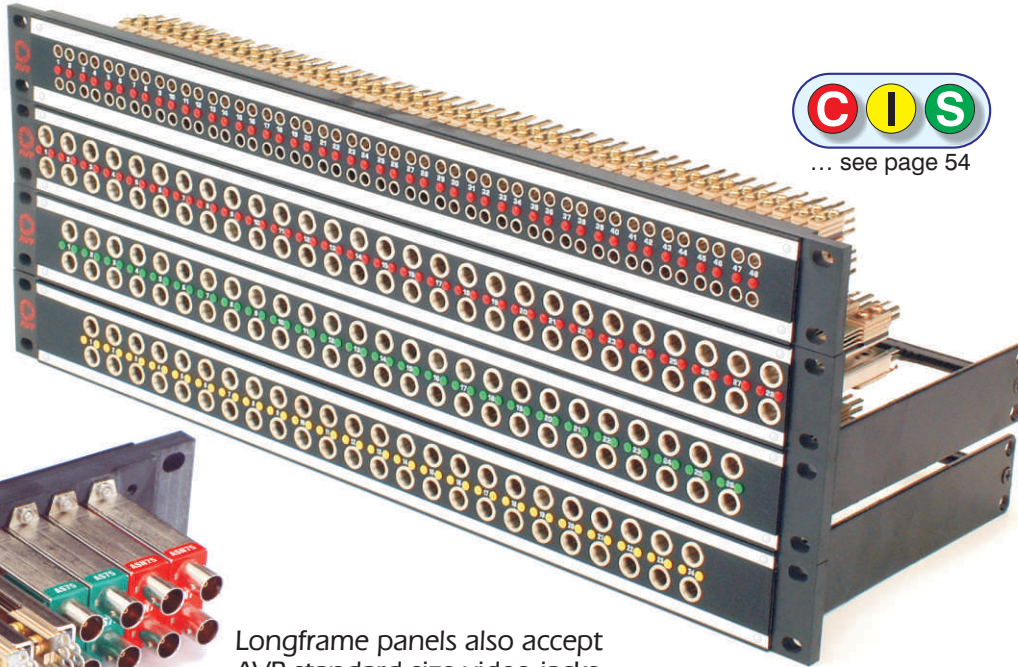

Longframe panels also accept AVP standard size video jacks



Panel Features

- Extensive Selection
 - Bantam, 2x48
 - Longframe, 2x24, 2x26, 2x28
 - 1RU, 1.5RU or 2RU
- Maximized Designations
- Front-mounting Jacks
- Captive Screws
- Heavy Duty Construction
- Cable bars secure all terminations (optional)

Audio Jack Features

- AVP Longframe and Bantam Jacks
- Certified for 30,000 mating cycles
 - Nickel-plated for corrosion resistance
 - Self-wiping gold contacts
 - Solder tail or wire-wrap
- (full specifications on page 41)

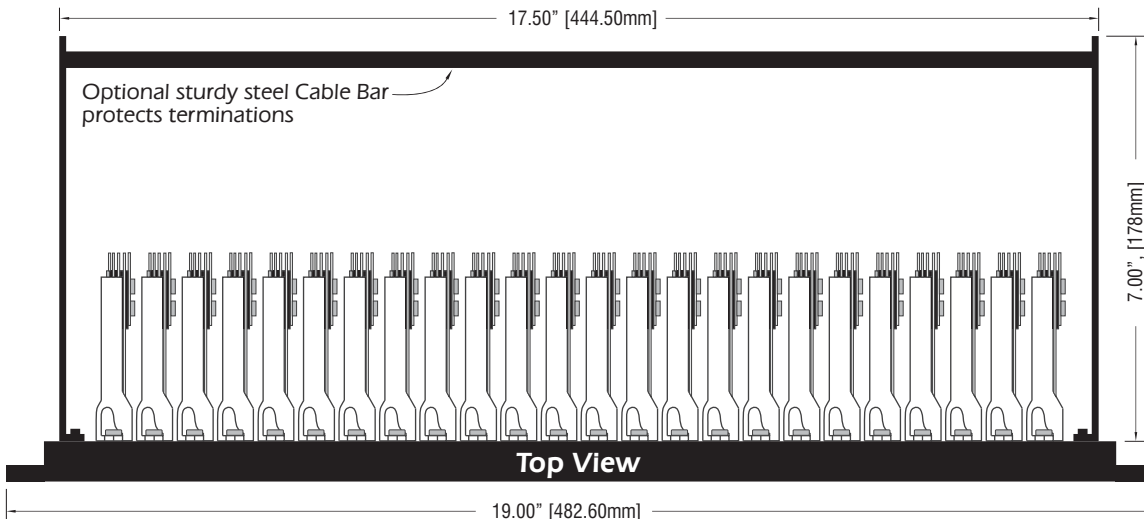

Partners in Broadcast, Telecom & Satellite Solutions

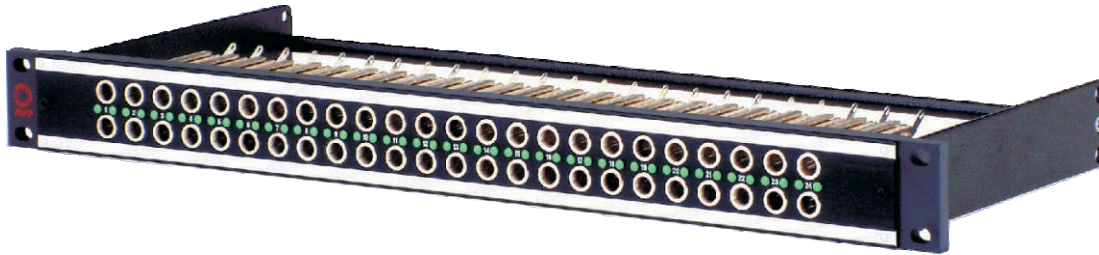

Series

- A Mosaic 
- T Mosaic (Black CIS)

Number of Jacks per Row

- 24 2x24 Jacks
- 26 2x26 Jacks
- 28 2x28 Jacks

Panel Height

- 1 1 Rack Unit 1.75", 44mm
- 15 1.5 Rack Unit 2.62", 66mm
- 2 2 Rack Unit 3.50", 89mm

Normaling

- FN Full Normal jumpers installed at jacks
- HN Half Normal jumpers installed at jacks
- NN No Normal jumpers installed at jacks

Installed Jack Type

- A1S Longframe Jacks with solder tails
- A1W Longframe Jacks with wire-wrap tails
- Z None (empty panel)

Options, add to end of Model Number

- BAR Heavy-duty Cable Bar,
- not available on 1RU 2x28 panels

Longframe Ordering Information

Designation Layouts... page 40

Popular Models

Model	Description
Longframe Jackpanels	
AJ-A224E1-A1S	1RU, 2x24, 48 Longframe Jacks with solder tails
AJ-A224E2-A1S	2RU, 2x24, 48 Longframe Jacks with solder tails

Longframe Jacks

AJ-A1S	1 Longframe Jack, solder, front-mount
AJ-A2S-FN	2 Longframe Jacks, solder, front-mount, Full Normal
AJ-A2S-HN	2 Longframe Jacks, solder, front-mount, Half Normal
AJ-A1W	1 Longframe Jack, wire-wrap, front-mount
AJ-A2W-FN	2 Longframe Jacks, wire-wrap, front-mount, Full Normal
AJ-A2W-HN	2 Longframe Jacks, wire-wrap, front-mount, Half Normal

Longframe Patchcords

	1'	300mm	LPC-1-BLACK	LPC-1-RED	LPC-1-GREEN	LPC-1-BLUE	LPC-1-YELLOW	
	1.5'	450mm	LPC-1.5-BLACK	LPC-1.5-RED	LPC-1.5-GREEN	LPC-1.5-BLUE	LPC-1.5-YELLOW	
	2'	600mm	LPC-2-BLACK	LPC-2-RED	LPC-2-GREEN	LPC-2-BLUE	LPC-2-YELLOW	
	3'	900mm	LPC-3-BLACK	LPC-3-RED	LPC-3-GREEN	LPC-3-BLUE	LPC-3-YELLOW	
	4'	1200mm	LPC-4-BLACK	LPC-4-RED	LPC-4-GREEN	LPC-4-BLUE	LPC-4-YELLOW	
	6'	1800mm	LPC-6-BLACK	LPC-6-RED	LPC-6-GREEN	LPC-6-BLUE	LPC-6-YELLOW	
	10'	3.05m	LPC-10-BLACK	LPC-10-RED	LPC-10-GREEN	LPC-10-BLUE	LPC-10-YELLOW	
	110 Ohm AES/EBU Digital and Analog Audio Application							
	... more patchcords available on page 54							

Longframe Audio Patchcords

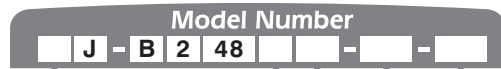
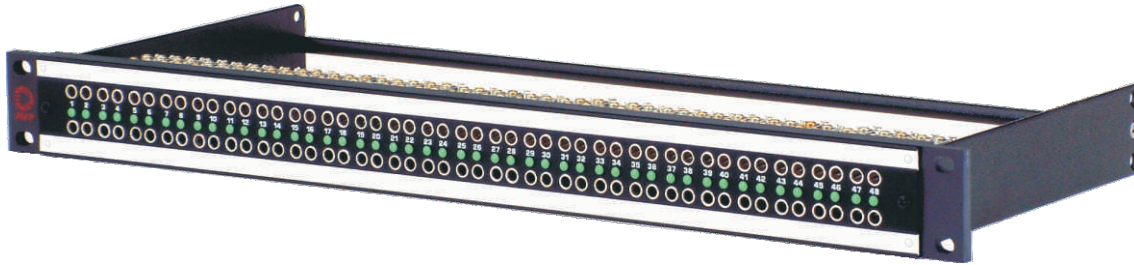

Series

- A Mosaic 
- T Mosaic (Black CIS)

Jack Spacing

- S Stereo Spaced (most common)
- E Even Spaced

Panel Height

- 1 1 Rack Unit 1.75", 44mm
- 15 1.5 Rack Unit 2.62", 66mm
- 2 2 Rack Unit 3.50", 89mm

Normaling

- FN Full Normal jumpers installed at jacks
- HN Half Normal jumpers installed at jacks
- NN No Normal jumpers installed at jacks

Installed Jack Type

- B1S Bantam Jacks with solder tails
- B1W Bantam Jacks with wire-wrap tails
- Z None (empty panel)

Options, add to end of Model Number

- BAR Heavy-duty Cable Bar

Bantam Ordering Information

Designation Layouts... page 39





Popular Models

Model	Description
Bantam Jackpanels	
AJ-B248S1-B1S	1RU, 2x48, 96 Bantam Jacks
AJ-B248S1-B1S-BAR	1RU, 2x48, 96 Bantam Jacks, Heavy-Duty Cable Bar

Bantam Jacks

AJ-B1S	1 Bantam Jack, solder, front-mount
AJ-B2S-FN	2 Bantam Jacks, solder, front-mount, Full Normal
AJ-B2S-HN	2 Bantam Jacks, solder, front-mount, Half Normal
AJ-B1W	1 Bantam Jack, wire-wrap, front-mount
AJ-B2W-FN	2 Bantam Jacks, wire-wrap, front-mount, Full Normal
AJ-B2W-HN	2 Bantam Jacks, wire-wrap, front-mount, Half Normal



Bantam Patchcords						
1'	300mm	BPC-1-BLACK	BPC-1-RED	BPC-1-GREEN	BPC-1-BLUE	BPC-1-YELLOW
1.5'	450mm	BPC-1.5-BLACK	BPC-1.5-RED	BPC-1.5-GREEN	BPC-1.5-BLUE	BPC-1.5-YELLOW
2'	600mm	BPC-2-BLACK	BPC-2-RED	BPC-2-GREEN	BPC-2-BLUE	BPC-2-YELLOW
3'	900mm	BPC-3-BLACK	BPC-3-RED	BPC-3-GREEN	BPC-3-BLUE	BPC-3-YELLOW
4'	1200mm	BPC-4-BLACK	BPC-4-RED	BPC-4-GREEN	BPC-4-BLUE	BPC-4-YELLOW
6'	1800mm	BPC-6-BLACK	BPC-6-RED	BPC-6-GREEN	BPC-6-BLUE	BPC-6-YELLOW
10'	3.05m	BPC-10-BLACK	BPC-10-RED	BPC-10-GREEN	BPC-10-BLUE	BPC-10-YELLOW

110 Ohm AES/EBU Digital and Analog Audio Application ...more patchcords available on page 54

Bantam Audio Patchcords



Audio Jack & Panel Assemblies

Designation Specifications

Bantam Designation Layouts

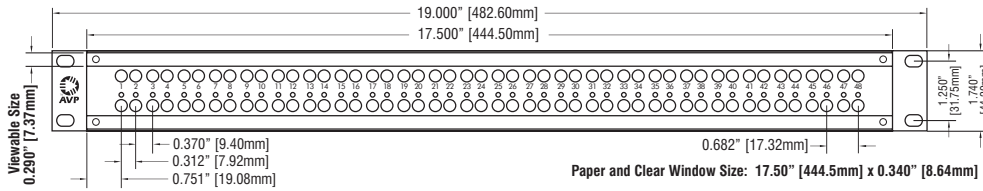

1RU Stereo Spaced

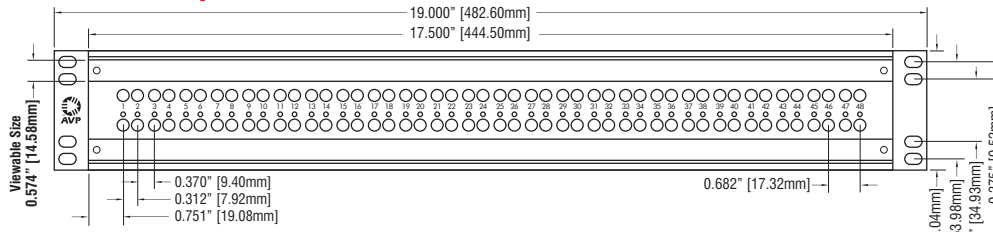

1.5RU Stereo Spaced

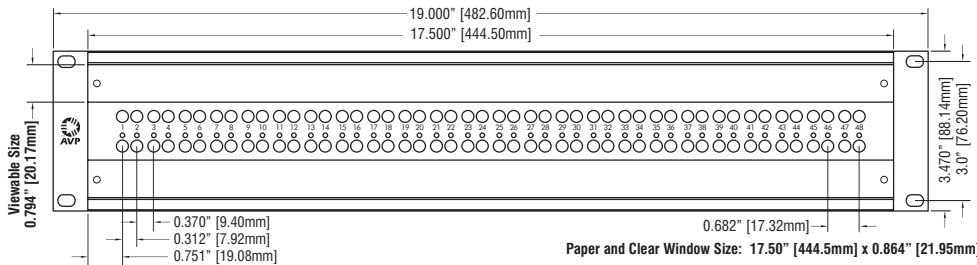

2RU Stereo Spaced

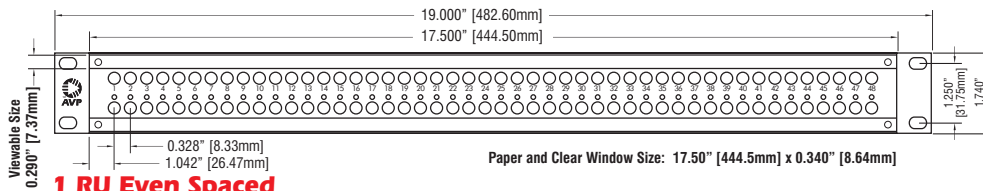

1RU Even Spaced

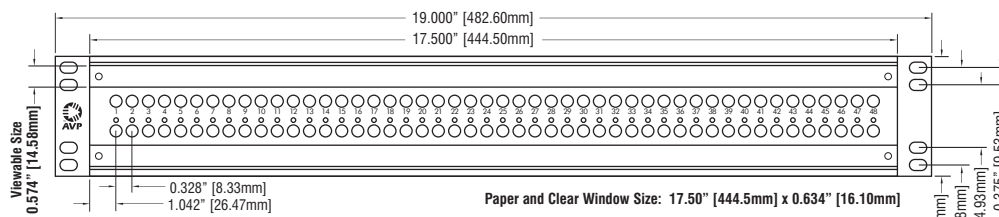

1.5RU Even Spaced

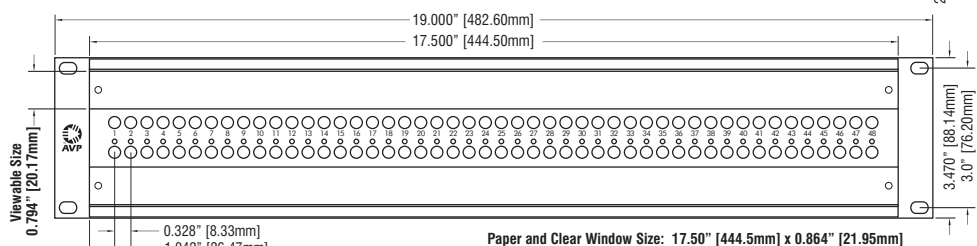

2RU Even Spaced

Longframe Designation Layouts

