

## Universal Bulkhead Panel System



**Universal Bulkhead System**

- Design your own bulkhead
- Extensive selection of connector modules
- 1RU, 2RU & 3RU, 16 & 12 position available
- Strain relief cable bar is standard

Model **WK-U216E2-Z**  
with optional Connector Kits

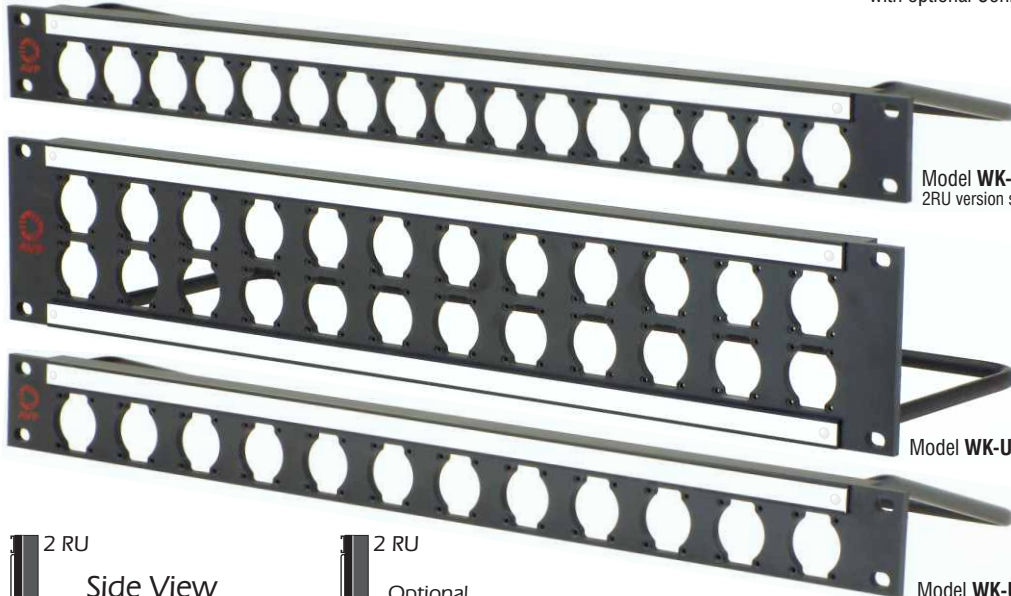

Model **WK-U116E1-Z**  
2RU version shown above

Model **WK-U212E2-Z**

Model **WK-U112E1-Z**

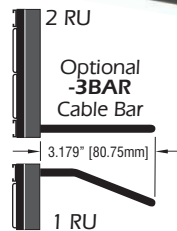
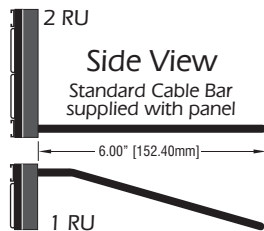

### Ordering Information

Model	Description
Universal Panel - Panel with 6.0" [152.40mm] Cable Bar Only; no Connectors, no Adaptor Plates, no Cover Plates	
<b>WK-U216E3-Z</b>	3RU, 2x16 Universal Panel, Panel & Cable Bar Only, No Connectors
<b>WK-U216E2-Z</b>	2RU, 2x16 Universal Panel, Panel & Cable Bar Only, No Connectors
<b>WK-U116E1-Z</b>	1RU, 1x16 Universal Panel, Panel & Cable Bar Only, No Connectors
<b>WK-U212E3-Z</b>	3RU, 2x12 Universal Panel, Panel & Cable Bar Only, No Connectors
<b>WK-U212E2-Z</b>	2RU, 2x12 Universal Panel, Panel & Cable Bar Only, No Connectors
<b>WK-U112E1-Z</b>	1RU, 1x12 Universal Panel, Panel & Cable Bar Only, No Connectors
Add <b>-3BAR</b> to end of Model Number	3.179" [80.75mm] Cable Bar instead of standard 6.0" [152.40mm] Cable Bar
<b>BUILD2</b>	2 or 3RU Assembly of connectors to panel
<b>BUILD1</b>	1 RU Assembly of connectors to panel

Designation Layouts... page 49

**Ordering Information**



# Insulated Bulkheads

Universal Bulkhead System

**Universal Bulkhead System**



## Universal Connector Kits



### Ordering Information

Model Description  
Connector Kits, kits include all components necessary to mount connector to panel

#### Audio

UE3R-C	EDAC Receptacle, 3 pin crimp, adaptor plate(s), hardware
UE3R-S	EDAC Receptacle, 3 pin solder, adaptor plate(s), hardware
UMIDI	MIDI Isolated Connector, solder type, hardware
UNL2MP	Speakon Connector, 2-Pole, solder termination, panel mount, hardware
UNL4MP	Speakon Connector, 4-Pole, solder termination, panel mount, hardware
UNL4MP-B	Speakon Connector, 4-Pole, black/gold contacts, solder, panel mount, h/w
UNX331	XLR, female, 3 pin, silver, solder termination, panel mount, hardware
UNY331	XLR, male, 3 pin, silver, solder termination, panel mount, hardware
UNX330	XLR female, 3 pin, black/gold contacts, solder, panel mount, hardware
UNY330	XLR male, 3 pin, black/gold contacts, solder, panel mount, hardware
UNX430	XLR female, 4 pin, black/gold contacts, solder, panel mount, hardware
UNY430	XLR male, 4 pin, black/gold contacts, solder, panel mount, hardware
UNX530	XLR female, 5 pin, black/gold contacts, solder, panel mount, hardware
UNY530	XLR male, 5 pin, black/gold contacts, solder, panel mount, hardware
UNX630	XLR female, 6 pin, black/gold contacts, solder, panel mount, hardware
UNY631-S	XLR female, 6 pin, silver, solder, Switchcraft equivalent, panel mount, hardware
UNY630	XLR male, 6 pin, black/gold contacts, solder, panel mount, hardware
UNX730	XLR female, 7 pin, black/gold contacts, solder, panel mount, hardware
UNY730	XLR male, 7 pin, black/gold contacts, solder, panel mount, hardware
URCA-RD	RCA Feedthru, red, adaptor plate(s), hardware
URCA-WH	RCA Feedthru, white, adaptor plate(s), hardware
URCA-YL	RCA Feedthru, yellow, adaptor plate(s), hardware
US35J	Stereo Mini-Audio Jack 3.5mm, female, solder, adaptor plate(s), hardware
USPJ	1/4" Stereo Phone Jack, solder termination, panel mount, hardware

#### Video

UHF310	F Style Feedthru, AVP HF310, adaptor plate(s), hardware
UHF310R	F Style Feedthru, recessed, AVP HF310, adaptor plate(s), hardware
UJJ300	BNC Coaxial Feedthru, 3 GHz, AVP JJ300, adaptor plate(s), hardware
UJJ300R	BNC Coaxial Feedthru, 3 GHz, recessed, AVP JJ300, adaptor plate(s), h/w
UBNC50-F	BNC Coaxial Feedthru, 50 Ohm, F-F, adapter plate(s), hardware
USMA	SMA 50 Ohm Coaxial Connector, feed-thru, f-f, adaptor plate(s), hardware
USVHS-4G	SVHS Feedthru, 4 pin, gold contacts, adaptor plate(s), hardware
USVHS-4N	SVHS Feedthru, 4 pin, nickel contacts, adaptor plate(s), hardware

#### Data, Network

UDB9-CF	DB9 Female, crimp contacts, adaptor plate(s), hardware
UDB9-CM	DB9 Male, crimp pin contacts, adaptor plate(s), hardware
UDB9-SF	DB9 Female, loose solder contacts, adaptor plate(s), hardware
UDB9-SM	DB9 Male, loose solder pin contacts, adaptor plate(s), hardware
UDB9-SCF	DB9 Female, pre-loaded solder cup contacts, adaptor plate(s), hardware
UDB9-SCM	DB9 Male, pre-loaded solder cup pin contacts, adaptor plate(s), hardware
UFW-4	FireWire, 4 pin, IEEE 1394, Feedthru, female-female, adaptor plate(s), hardware
UFW-6	FireWire, 6 pin, IEEE 1394, Feedthru, female-female, chassis mount, hardware
UHD15-CF	HD15/VGA 15 pin connector, female, crimp, adaptor plate(s), hardware
UHD15-CM	HD15/VGA 15 pin connector, male, crimp, adaptor plate(s), hardware
UHDMI-DFF	HDMI feedthru, female-female, chassis mount, hardware
UMD66FF	Mini Din Feedthru, 6 pin female-female, PS/2, keyboard, adaptor plate(s), hardware
URJ11-F	RJ11 6 pos/6 con, Feedthru, female-female, adaptor plate(s), hardware
URJ11	RJ11 6 pos/6 con, IDC interface, adaptor plate(s), hardware (tool-less termination)
URJ45-F	RJ45 CAT5E, Feedthru, female-female, adaptor plate(s), hardware
URJ45-5E	RJ45 CAT5E, 110 interface, no door, adaptor plate(s), hardware (req. 110 punch tool)
URJ45-6	RJ45 CAT6, 110 interface, no door, adaptor plate(s), hardware (tool-less termination)
URJ45-6A	RJ45 CAT6A, 110 interface, no door, adaptor plate(s), hardware (req. 110 punch tool)
URJ45-6AS	RJ45 CAT6A, EMI/RFI Shielding, die-cast housing, adaptor plate(s), h/w (tool-less term.)
URJ45-6F	RJ45 CAT6, Feedthru, female-female, adaptor plate(s), hardware
USB-A	USB Type A Feedthru, female-female, adaptor plate(s), hardware
USB-B	USB Type B Feedthru, female-female, adaptor plate(s), hardware
USB-AB	USB Type A front, Type B on rear, female-female, adaptor plate(s), hardware

#### Fiber Optic

UFO-ST	ST fiber optic coupler, feed-thru, female-female, adaptor plate(s), hardware
ULCD-T	LC Duplex Adaptor suitable for singlemode & multimode applications, adaptor plate(s), h/w
ULCD-MM	LC Duplex Adaptor for Multimode applications, adaptor plate(s), hardware
USC-0	SC Multimode fiber optic connector, feed-thru, female-female, adaptor plate(s), hardware
USC-1	SC Singlemode/Multimode fiber optic connector, feed-thru, f-f, adaptor plate(s), hardware
UTOS	Toslink optical audio coupler, feed-thru, adaptor plate(s), hardware

#### Miscellaneous

UCP	Blank Cover Plate, black, hardware, covers one position
UB2-M	Banana Jacks, 2, red/black, solder, adaptor plate(s), hardware
UB3-M	Banana Jacks, 3, red/black/green, solder, adaptor plate(s), hardware
UBP1-S	Binding Post, single, green, solder, will accept banana jacks, adaptor plate(s), h/w
UBP2-S	Binding Posts, double, red/black, solder, will accept banana jacks, adaptor plate(s), h/w
UTNC-F	TNC Coaxial Adapter, Feedthru, F-F, 50 Ohm, adaptor plate(s), hardware
UMTS-L	Miniature Toggle Switch, DPDT, Locking Handle, 3 Amps, 250VAC, Solder, adaptor plate(s), h/w

\*Call if the connector you need is not shown above.

Partners in Broadcast, Telecom & Satellite Solutions



# Insulated Bulkheads

Universal Bulkhead System

## Designation Layouts

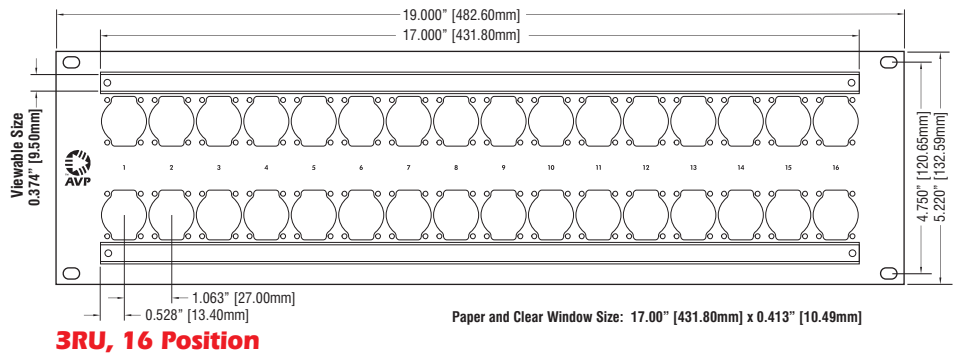
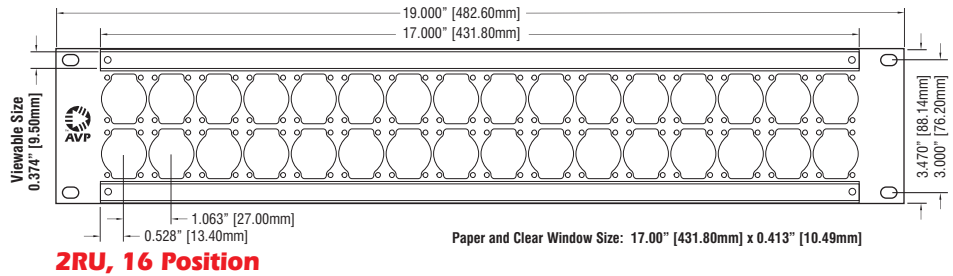
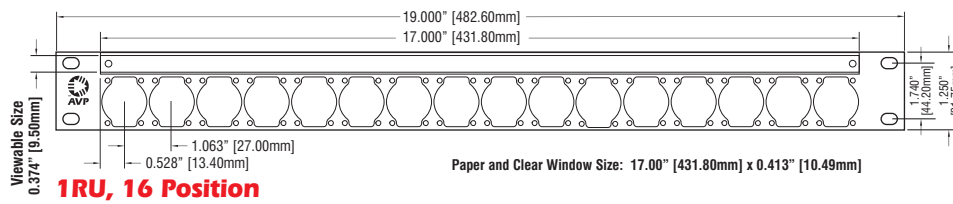
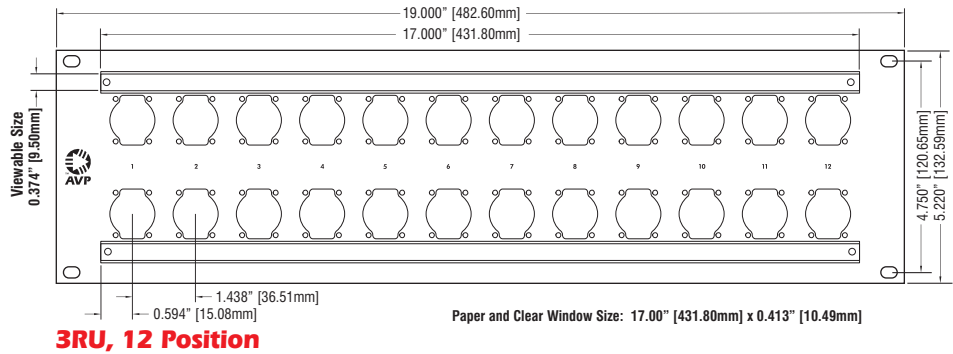
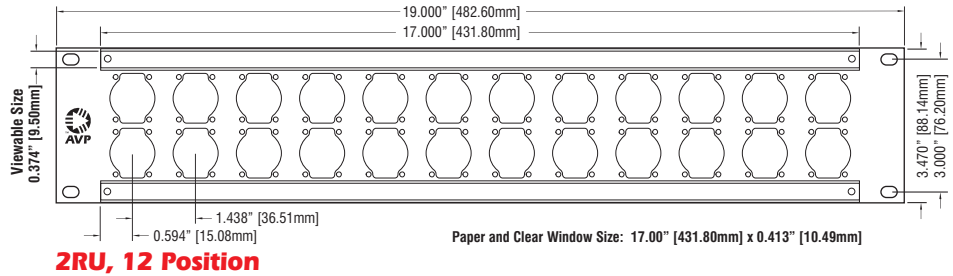
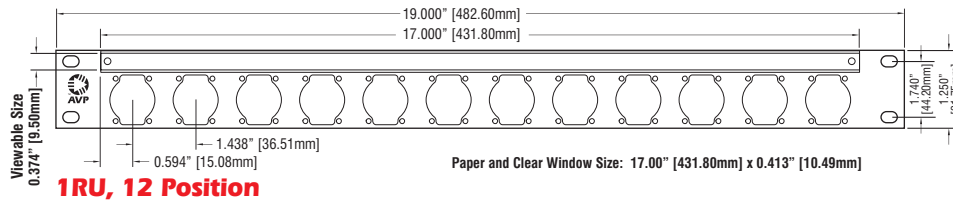

Partners in Broadcast, Telecom & Satellite Solutions